

Typical Glazing Bar Details

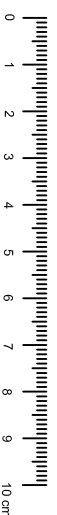

REF 301 - 01.09.08

Typical Glazing Bar Details

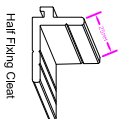
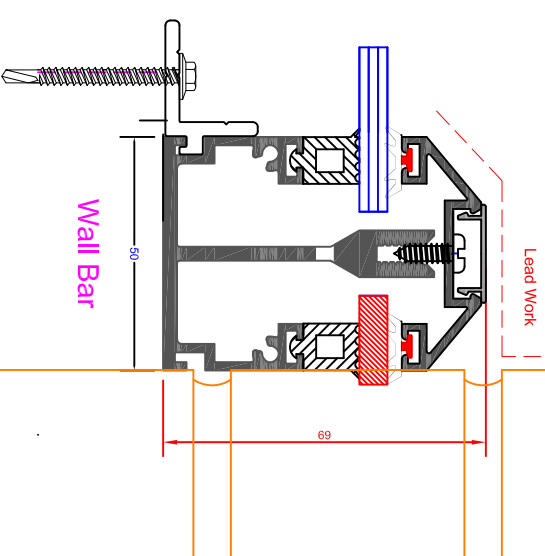
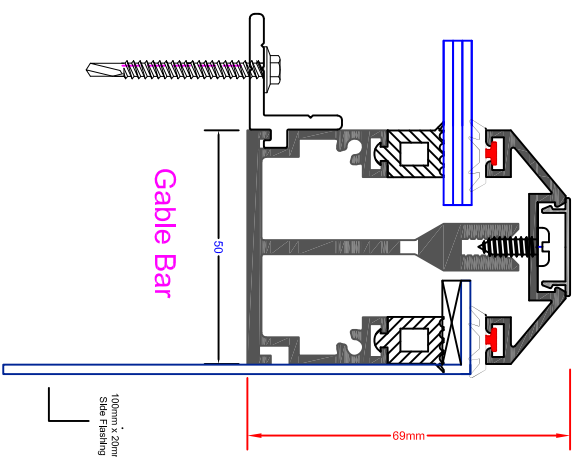
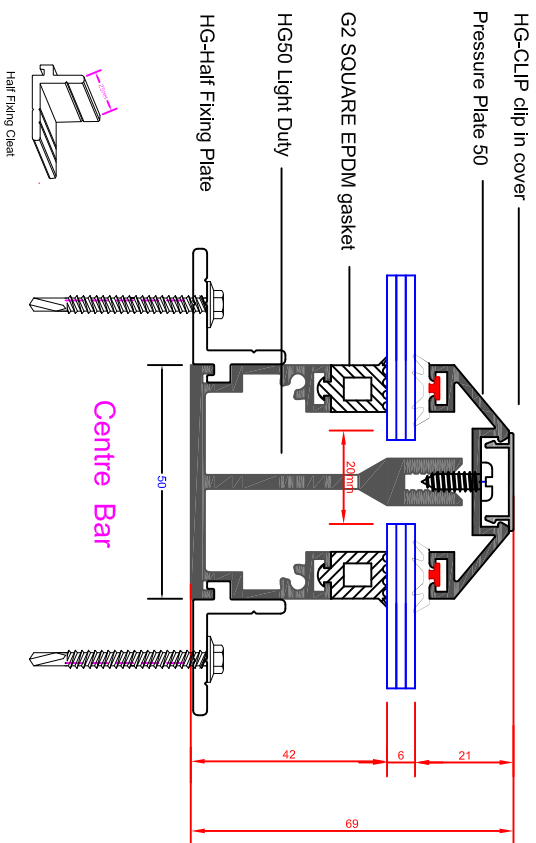
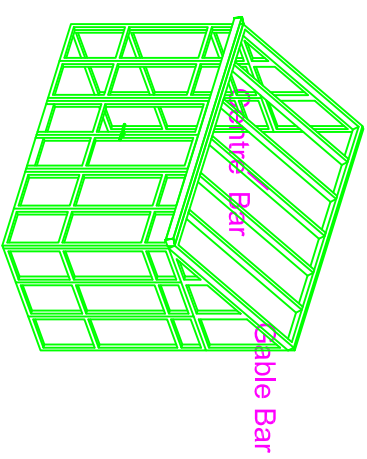
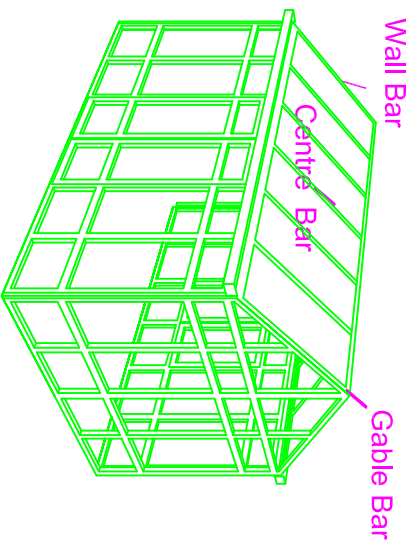